

ultracraft®





Let's Get Started.

On the leading edge of fashion and function, UltraCraft Cabinetry offers uncompromising quality, fit, and finish.

Browse the pages here to see what is possible. Add your personal taste and imagination. Collaborate with your local kitchen designer and craft your custom kitchen for your unique home and lifestyle. When it's done, gather in family and friends and enjoy your new kitchen together.

- UltraLux: *Ultra Contemporary*..... 4-11
- See It In Your Mind. Hold It In Your Hands.....5
- Textured Melamine: *Today's Look and Feel*12-21
- Integrated Pulls 15
- Thinking Outside The Box..... 17
- Thinking Inside The Box 23
- Thermofoil: *Easy Care and Value*22-29
- Wood: *Classic, Natural Beauty*..... 30-63
- Mix, Match, and Marry35
- Deluxe Veneer: *Exotic and Sustainable Options*..... 45
- Eurotek: *High Style, High Value* 64-65
- Metal: *A Glint of Jewelry*..... 66-71
- Glass: *Show Off A Little*.....70-73
- Accessories74-79
- UltraCraft Advantages: *Performance Construction*..... 80-81
- 100-Year Limited Warranty82
- Cabinet Care83

 For a gallery of additional photos and more information about UltraCraft, visit us on Houzz.com.

ultracraft®

Avon door style in Maple with Natural stain and Moss Green paint; AF002 Metal door style in Gold with Low Iron Clear Tech Glass.



South Beach door style in Pure White and Linear Silver UltraLux.

See It In Your Mind. Then Hold It In Your Hands.

Enjoy life-size samples of your favorite door/finish combinations in your home before you order cabinets.

UltraCraft Cabinetry color/finish/material/style combinations are virtually limitless! Your kitchen designer will help you define your favorite looks on your way to your new kitchen.

Sample doors are the best way to visualize what your ideas will look like in your home. Printed posters and brochures, and even designers' color chips, will never be as accurate - or as exciting - as a sample door custom-made to your specifications.

Before you order cabinets, order sample doors of the combinations you're most excited about. They'll be ready to ship in about a week. Live with the samples in your home until you know which look suits your family the best.





South Beach door style in Flint UltraLux.



Martin door style in Reclaimed Grey Textured Melamine and Acrilux II door style in Linear Bronze UltraLux.

Ultra Contemporary

UltraLux

If you want to maximize the contemporary style of your kitchen or bath, UltraLux is an excellent choice. Clean, sleek door designs add height to your room, while glossy, highly-reflective finishes make the whole room shine. Not a fan of high-gloss? We also offer Matte finishes that give you the look of a painted door with increased durability. UltraLux's minimalism and Metal Drawer system will create a luxurious atmosphere and a sophisticated, contemporary appeal.

Our Metallic-look and Solid Color finishes are made by laminating a sheet of acrylic or polyethylene terephthalate (PET) to a door form made of medium-density fiberboard (MDF) and are engineered to be

the most scratch-resistant, high-gloss acrylic surfaces available. What more do you need... Dry Erase board performance? You got it. And when you wipe away the marker, the surface won't ghost—guaranteed!

Linear finishes feature a high-gloss laminate film with a subtle graphic and UltraMatte finishes are ideal if you want a silky look.

UltraLux can hold its own as a flagship feature in many defined styles such as modern, European, Asian, and minimalist. It will also deliver the look and feel of no-frills extravagance when combined with door styles and materials from our other programs.

Finishes

UltraMatte Acrylic

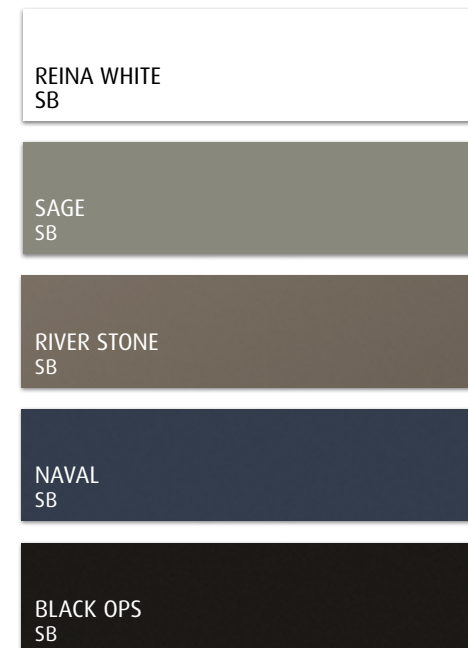

Linear-Pattern, High-Gloss Acrylic

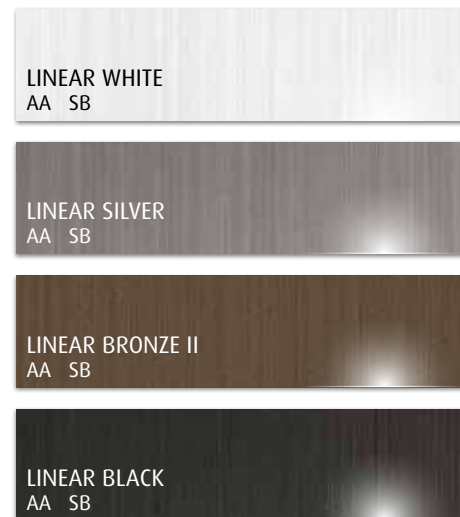

Metallic-Look, High-Gloss Acrylic

The most scratch-resistant, high-gloss acrylic surface available. Dry Erase-certified. Guaranteed never to ghost!



Door Styles



ACRILUX II

Matching drawer front
Shown in Linear Silver
Available in every high-gloss finish
Aluminum-look edgebanding
Available with Integrated Pulls (page 15)

EDGEWATER

Matching drawer front
Shown in Champagne Metallic
Available all Solid Color and Metallic-Look high-gloss finishes
Two-tone edgebanding

SOUTH BEACH

Matching drawer front
Shown in Carbon
Available in every finish
Matching edgebanding
Available with Integrated Pulls (page 15)

Solid-Color, High-Gloss Acrylic

The most scratch-resistant, high-gloss acrylic surface available. Dry Erase-certified. Guaranteed never to ghost!

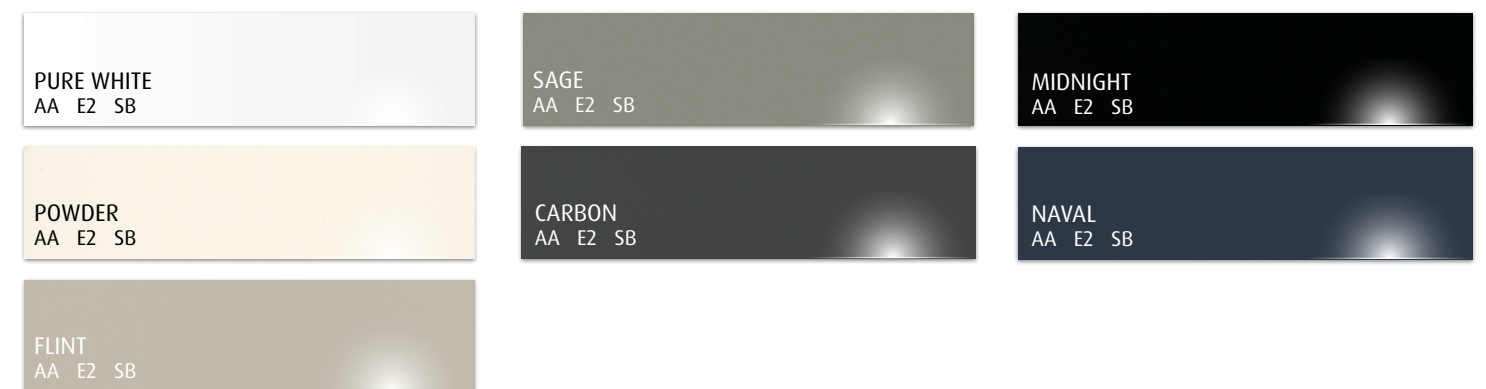

Finish availability by door style:
AA = Acrilux II/Aluminum-look Edgebanding E2 = Edgewater/Two-tone Edgebanding SB = South Beach/Matching Edgebanding

Not all colors and finishes are available on all door styles. Printed and digital materials should never be used for color matching. We recommend ordering a sample door to see the best representation of your selected color, finish, and wood grain contrast and patterns on your selected door style, before ordering cabinetry. Sample doors are more accurate than any website, printed literature, or designer's color chips. See your designer for details.



Piper door style in Sienna Textured Melamine and Marshall door style in Moss Green paint.



Metropolis door style in Silver Elm Vertical Textured Melamine and South Beach door style in Linear White UltraLux.

Integrated Pulls

Door and drawer hardware is decorative, functional and opinionated. Sometimes louder is better, but these new integrated pulls are quietly reserved and minimalist. Then again, if silence is what you need, try our Touch Latches and Metal Drawers with factory-installed Touch-To-Open.

Integrated pulls are available on Acrilux II and South Beach UltraLux door styles (pages 10-11) and Metropolis and Piper Textured Melamine door styles (pages 18-19).



INTEGRATED
C-PULL



INTEGRATED
L-PULL
(SHOWN LEFT)





Piper door style in Charred Vertical and Archicrete Textured Melamine and AF006 door style in Natural Aluminum with Bronze Matte Tech Glass inserts.

Thinking Outside The Box

Our door materials are available as panels that can be used in your kitchen to cover... well, most anything. This homeowner and UltraCraft designer chose Archicrete Textured Melamine panels to wrap the island sides and back. Archicrete looks like concrete and ramps up the industrial style in this kitchen. Why not a "concrete" wall too? More panels cover the wall behind the cabinets all the way up to the high ceiling.



In addition to faux-concrete panels, we offer subtle-to-bright colors, silky matte, high-gloss, aluminum, paint, textures, real wood, and simulated wood from bleached to weathered to charred.

Today's Look and Feel

Textured Melamine

Smooth is no longer the only option. Textured Melamine is becoming one of the most popular options for today's homeowners. Choose the 3D character and feel of a wood door but in a product that's unaffected by humidity, easy to care for and affordably priced.

Modern technology has made melamine an incredibly attractive option in both price and look. UltraCraft Textured Melamine doors are made by thermally-fusing a printed, resin-covered, textured paper to a door form made of medium-density fiberboard (MDF). The result is a

durable, low-maintenance finish with an exciting texture that simulates a variety of real woods.

Our offering of Textured Melamine includes popular door styles which you can combine with an array of colors, wood grains, horizontal or vertical grain directions and degrees of texture.

If you want to create a warm, inviting room but prefer a wood-alternative product that can stand up to your life at home, try Textured Melamine.



Finishes

Fine-Textured



Finish availability by door style:
 ME = Metropolis KH = Kitty Hawk
 P = Piper MA = Martin

Door Styles



METROPOLIS
 Matching drawer front
 Available with either vertical or horizontal grain direction
 Shown in Flame Oak Vertical
 Available with Integrated Pulls (page 15)



PIPER
 Matching drawer front
 Available with either vertical or horizontal grain direction
 Shown in Light Carbonite Horizontal
 Available with Integrated Pulls (page 15)



KITTY HAWK
 Slab or Matching drawer front
 Features both vertical and horizontal grain directions which cannot be altered
 Shown in Vineyard Oak



MARTIN
 Matching 3-PC drawer front
 Features both vertical and horizontal grain directions which cannot be altered
 Shown in Wired Silver

Coarse-Textured



Not all colors and finishes are available on all door styles. Printed and digital materials should never be used for color matching. We recommend ordering a sample door to see the best representation of your selected color, finish, and wood grain contrast and patterns on your selected door style, before ordering cabinetry. Sample doors are more accurate than any website, printed literature, or designer's color chips. See your designer for details.



Kitty Hawk door style in Rift White Pine Textured Melamine and Chesapeake door style in Mineral Grey paint.



Thinking Inside The Box



15% MORE STORAGE SPACE!
Full-access cabinets have up to 15% more storage space than framed cabinets. And no knuckle-nicking frame or center stile to impede access to stored items. Go ahead and buy those large plates you've had your eye on.

INTERIOR FINISHES
Insides (and outsides!) are protected with moisture-resistant, easy-to-clean melamine. Interiors of cabinets with glass doors, or no doors, are color-coordinated to look great with the overall look of the kitchen.

EDGES
Front edges have matching or coordinating edgebanding. All edges (except inside edges of top stretchers) are covered for moisture-resistance.

SHELVES
Adjustable, full-depth shelves are 3/4"-thick, edgebanded, and supported with metal shelf clips.

HINGES
Durable, self-closing hinges are 6-way-adjustable for precision door alignment.

Learn more about UltraCraft Advantages and Performance Construction on pages 80-81.



Piper door style in Sienna Textured Melamine and South Beach door style in Black Ops UltraMatte UltraLux. Wall panels in Archicrete and Sienna Textured Melamine.



Adriatic door style in Matte White Thermofoil, AF003 Metal door style in Onyx with Clear Tech Glass, and Sienna Textured Melamine panels.

Easy Care and Value

Thermofoil

Our Thermofoil doors bring you easy maintenance, long-lasting durability and beautiful styles, colors and finishes, making this option one of the best values in cabinetry.

Made by the heat-and-vacuum application of a rigid vinyl to a door form made of medium-density fiberboard (MDF), Thermofoil doors provide a flawless finish with a clean, smooth surface and superior stability.

Thermofoil is low-maintenance due to its moisture-, chip-, and stain-resistant finishes. Its easy care is appealing to

many busy families. For most kitchen splatters and spills, Thermofoil cabinets can be easily wiped clean with a soft damp cloth.

Door styles range from modern square- and beveled-edge slabs to traditional raised-panel looks with transitional, Shaker-style in-between. High-gloss on a slab-style door shouts urban contemporary, but any color on a door with a center panel captures the beauty of classic painted wood at a much lower cost.

Door Styles:

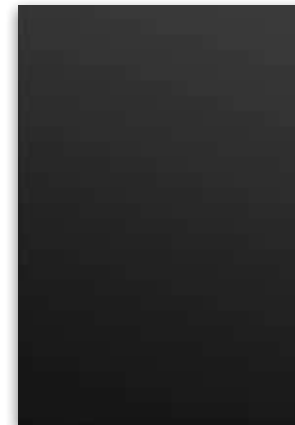

ADRIATIC
Matching drawer front
Available in all Thermofoil finishes
Shown in Coal



MISSION II
Slab or Matching drawer front
Available in Matte White, Satin White, Shark, Coal, and Haze
Shown in Shark



LEXINGTON
Slab or Matching drawer front
Available in Matte White, Satin White, Coal, and Haze
Shown in Haze



CELLINI
Matching drawer front
Available in all Thermofoil finishes
Shown in Silver Walnut



Adriatic door style in Shark Thermofoil. Designer: Jorge A. Martinez, CKD, Designer Kitchens LA.

Finishes:



MATTE WHITE

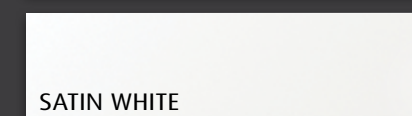

SATIN WHITE

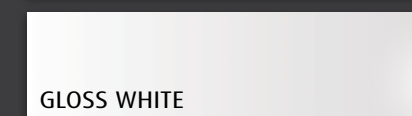

GLOSS WHITE

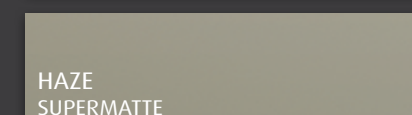

HAZE
SUPERMATTE



SHARK



SILVER WALNUT

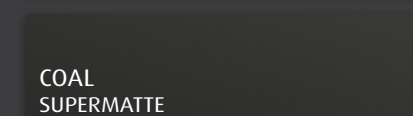

COAL
SUPERMATTE

Not all colors and finishes are available on all door styles. Printed and digital materials should never be used for color matching. We recommend ordering a sample door to see the best representation of your selected color, finish, and wood grain contrast and patterns on your selected door style, before ordering cabinetry. Sample doors are more accurate than any website, printed literature, or designer's color chips. See your designer for details.



Richmond II door style in Walnut with Natural stain (low sheen) and Adriatic door style in Coal SuperMatte Thermofoil.*

**Walnut is prized for its natural, wide-ranging variations in grain contrast, patterns, and color. Since no single image can capture the variety possible with Walnut, please consult with your designer about what to expect.*



Andover door style with Arctic White paint and Brown Linen glaze. Designer: Samina Datta, Reico Kitchen & Bath. Photo: BTW Images, LLC.



Stickley door style in Rustic Alder with Natural stain and Lakeway door style with Blue Ash paint.

Mix, Match, and Marry

These days many kitchen designs include an island in a different color, finish, or material than the perimeter cabinets. Here lighter, stained wood is paired with darker, painted wood in a contrasting color and in two different door styles.

We love designs that pair recessed panel wood doors with slab wood doors. Gloss looks even brighter when paired with matte. Texture works well with both gloss and matte.

There are no limits. Choose more than one combination. Order sample doors of your pairings and look at them in your home to help you decide.

Here are a few of our favorites:

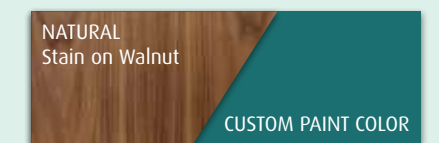
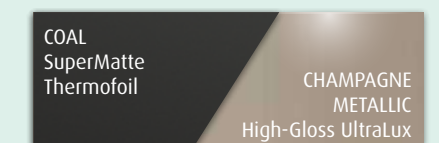
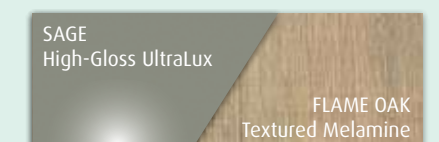
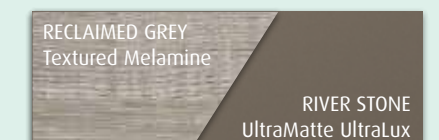
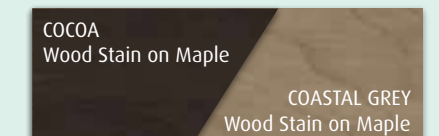



Evanston door style in Oak with Platinum Grey stain.

Classic, Natural Beauty

Wood Door Styles

Wood is the most traditional choice for cabinet doors. Our Wood Program provides an incredible range of options that are relevant to today's design and architectural styles. You can achieve almost any look or ambiance you want by marrying the door styles, colors, and finishes that excite you.

Our selection of door styles is diverse: simple, traditional, ornate, multi-dimensional, raised panels, recessed panels, wide stiles, thin stiles, and more. And keep in mind each door can provide a very different look depending on the colors, finishes, and drawer fronts you combine.

Because they are a natural material, wood doors add an overall softness to kitchens, yet are strong and durable. Enhance their natural beauty with stains and finishes that allow the unique characteristics of your wood species to come through, like knots, color variations, and grain patterns. Or have your doors painted for a bolder, more consistent color presentation, still awarding you with wood's comfortable attitude.

Need a little more character than a stain or paint can provide? Check out our low-charge, specialty glaze and distressed finishes to further influence your unique look.

Recessed Panel Wood Door Styles



CHESAPEAKE
Slab or Matching drawer front
Shown in Mineral Grey
O M C A RB



BRECKENRIDGE
Matching drawer front
Shown in Melted Brie
O M C RC A RA RB



MARSHALL
Slab or Matching drawer front
Shown in Walnut*, Natural
O M C A RB W



LAKEWAY
Slab or Matching drawer front
Shown in Pebble Grey
O M C A RB



ANDOVER
Slab or Matching drawer front
Shown in Maple, Briarwood,
Brown Glaze
O M C A RB



AVON
Slab or Matching drawer front
Shown in Wings
O M C A RB MDF



AVON WIDE
Slab or Matching drawer front
Shown in Arctic White
O M C A RB MDF



BOCA RATON
Matching drawer front
Shown in Cherry, Wenge
O M C



BRECKENRIDGE WIDE
Matching drawer front
Shown in Maple, Caramel,
Mocha Glaze
O M C RC A RA RB



BRISTOL
Slab or Matching drawer front
Shown in Beach White
O M C A RB



BROADVIEW
Slab or Matching drawer front
Shown in Alder, Storm Grey
O M C A RB



CHARLOTTE
Slab or Matching drawer front
Shown in Maple, Saddle
O M C A RB



CRYSTAL LAKE
Slab or Matching drawer front
Shown in Melted Brie
O M C RC A RA RB



DAYTONA
Slab or Matching drawer front
Shown in Oak, Briarwood
O M C A RB



DENNISON
Slab or Matching drawer front
Shown in Cherry, Caramel
O M C A RB



FRISCO
Matching drawer front
Shown in Maple, Briarwood
O M C



HAMPTON
Slab or Matching drawer front
Shown in Stone, Brown Glaze
O M C A RB



LAFAYETTE
Slab or Matching drawer front
Shown in Maple, Coastal Grey,
Mocha Glaze
O M C A RB



LAUDERDALE
Slab or Matching drawer front
Shown in Melted Brie
O M C A RB

Available Species: O=Oak M=Maple C=Cherry RC=Rustic Cherry A=Alder RA=Rustic Alder RB=Red Birch W=Walnut MDF=Medium Density Fiberboard

*Walnut is prized for its natural, wide-ranging variations in grain contrast, patterns, and color. Since no single image can capture the variety possible with Walnut, please consult with your designer about what to expect.

Not all colors and finishes are available on all door styles. Printed and digital materials should never be used for color matching. We recommend ordering a sample door to see the best representation of your selected color, finish, and wood grain contrast and patterns on your selected door style, before ordering cabinetry. Sample doors are more accurate than any website, printed literature, or designer's color chips. See your designer for details.

Recessed Panel Wood Door Styles, cont.



SHAKER
Slab or Matching drawer front
Shown in Walnut*, Natural
O M C A RB W MDF



WICKER PARK
Slab or Matching drawer front
Shown in Blue Ash
O M C RC A RA RB



ROCKFORD
Slab or Matching drawer front
Shown in Alder Storm Grey
O M C A RB



PLAINVIEW WIDE
Slab or Matching drawer front
Shown in Red Birch, Natural
O M C A RB



OAKLAND PARK
Slab or Matching drawer front
Shown in Lunar Gray,
Brown Linen
O M C A RB



NASHTON WIDE
Slab or Matching drawer front
Shown in Creekstone
O M C A RB



PLAINVIEW
Slab or Matching drawer front
Shown in Melted Brie
O M C A RB



PLANTATION
Slab or Matching drawer front
Shown in Oak, Cocoa
O M C RC A RA RB



RIDGECREST
Slab or Matching drawer front
Shown in Moon Bay
O M C A RB



SAGAMORE
Slab or Matching drawer front
Shown in Alder, Storm Grey
O M C RC A RA RB



SARASOTA
Slab or Matching drawer front
Shown in Oak, Nutmeg
O M C RC A RA RB



SHAKER WIDE
Slab or Matching drawer front
Shown in Red Birch, Natural
O M C A RB MDF



STICKLEY
Slab or Matching drawer front
Shown in Rustic Alder, Natural
O M C RC A RA RB



STICKLEY WIDE
Slab or Matching drawer front
Shown in Oak, Chestnut
O M C RC A RA RB



WINCHESTER
Matching drawer front
Shown in Maple, Briarwood
O M C RC A RA RB

Available Species: O=Oak M=Maple C=Cherry RC=Rustic Cherry A=Alder RA=Rustic Alder RB=Red Birch W=Walnut MDF=Medium Density Fiberboard



Plainview Wide door style in Rag & Bone paint. Designer: Tres Jolie Maison. Photo: Kim Smith.

*Walnut is prized for its natural, wide-ranging variations in grain contrast, patterns, and color. Since no single image can capture the variety possible with Walnut, please consult with your designer about what to expect.

Not all colors and finishes are available on all door styles. Printed and digital materials should never be used for color matching. We recommend ordering a sample door to see the best representation of your selected color, finish, and wood grain contrast and patterns on your selected door style, before ordering cabinetry. Sample doors are more accurate than any website, printed literature, or designer's color chips. See your designer for details.

Raised Panel Wood Door Styles



ASHEVILLE
Matching drawer front
Shown in Maple, Chocolate,
Brown Glaze
O M C RC A RA RB



BOSTON
Contoured Slab or
Matching drawer front
Shown in Cherry, Nutmeg,
Brown Glaze
O M C RC A RA RB



EVANSTON
Slab or Matching drawer front
Shown in Mineral Grey,
Brown Glaze
O M C RC A RA RB



FAIRLAWN
Slab or Matching drawer front
Shown in Rustic Cherry,
Chestnut
O M C RC A RA RB



LIVINGSTON
Matching drawer front
Shown in Cherry,
Peppercorn
O M C RC A RA RB



MOUNT VERNON
Matching drawer front
Shown in Red Birch, Porcini
O M C RC A RA RB



PLYMOUTH
Matching drawer front
Shown in Cherry, Briarwood
O M C

Available Species:
O=Oak RA=Rustic Alder
M=Maple RB=Red Birch
C=Cherry W=Walnut
RC=Rustic Cherry MDF=Medium
A=Alder Density Fiberboard

Not all colors and finishes are available on all door styles. Printed and digital materials should never be used for color matching. We recommend ordering a sample door to see the best representation of your selected color, finish, and wood grain contrast and patterns on your selected door style, before ordering cabinetry. Sample doors are more accurate than any website, printed literature, or designer's color chips. See your designer for details.



RAISED
Slab or Matching drawer front
Shown in Maple, Amber
M C



ROYALTON
Slab or Matching drawer front
Shown in Vintage Lunar Gray
O M C RC A RA RB



Raised door style in Urban Gray paint. Hampton door style in Mineral Grey paint with Nickel Linen glaze. Designer: Jenny Roush Newman, West End Cabinet Company. J. Sinclair Photography.

A Clean and Simple Wood Look

Slab Wood Door Styles

Slab-style, doors are the most modern of the wood looks, and unlike solid wood, these doors are virtually unaffected by changes in temperature and humidity.

The only ornamentation on a slab door is the finish itself—any paint color or striking wood veneer. Choose paint and the look will be about color. Choose wood veneer and show off the unique grain patterns of natural wood.

RICHMOND II

Eased edge
Slab drawer front
Wood veneer, vertical grain only

Available in Oak, Maple, Cherry and Walnut with Stain finishes only; no Specialty finishes
Shown in Walnut*, Natural



Richmond II door style in Walnut with Natural stain. Designer: Gretchen Ferreira of Style Bath & Kitchen and Meryl Phillips-Miller of Meryl & Miller. Open Homes Photography.*

SLAB

Square edge
Slab drawer front
Wood veneer, vertical grain only

Available in Oak, Maple and Cherry with Stain finishes only; no Specialty finishes
Shown in Oak, Storm Grey



Slab door style in Oak with Storm Grey stain.

APEX

1/8" Round-Over Edge
Slab drawer front
MDF door available in any Paint color and Linen finishes only
Shown in Moon Bay



Apex door style with Moon Bay paint.

*Walnut is prized for its natural, wide-ranging variations in grain contrast, patterns, and color. Since no single image can capture the variety possible with Walnut, please consult with your designer about what to expect.

Exotic and Sustainable Options

Deluxe Veneer

Looking for extraordinarily beautiful cabinet doors in an eco-friendly material? Our Deluxe Veneers made of Bamboo or Rift Cut Oak bring you exotic looks from sustainable sources.

Fast-growing Bamboo is both renewable and sustainable. Our Bamboo veneer is made by thinly slicing blocks of compressed Bamboo shoots, giving each veneer a textured surface and original aesthetic patterns made from growth joints and grains. Bamboo is exceptionally durable with low maintenance.

Cut into a log perpendicular to its growth rings—a rift cut—and the result is lumber with a linear grain pattern. Our Rift Cut Oak veneers are made by combining pieces of dyed rift-cut oak to form a wood block of intentional grain and color. Thinly slicing the block produces veneers which mimic the look of uncommon wood species.

Horizontal or vertical grain direction, a natural finish or a tint of color, whatever your favorites, make a bold visual statement with our Deluxe Veneers. They'll be the centerpiece of your kitchen and your conversations.

Bamboo – horizontal or vertical grain

Available on Slab door style

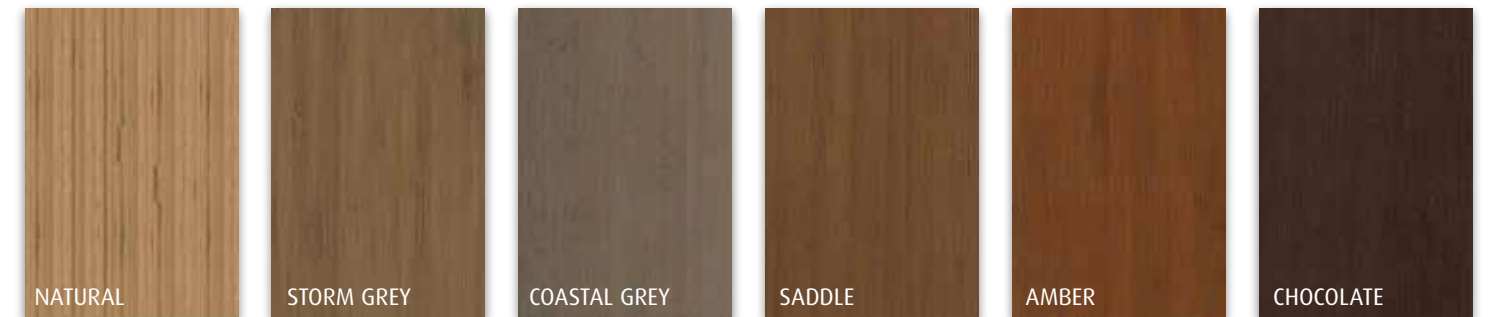

Rift Cut Oak – horizontal or vertical grain

Available on Slab door style



Not all colors and finishes are available on all door styles. Printed and digital materials should never be used for color matching. We recommend ordering a sample door to see the best representation of your selected color, finish, and wood grain contrast and patterns on your selected door style, before ordering cabinetry. Sample doors are more accurate than any website, printed literature, or designer's color chips. See your designer for details.

Celebrate the Nature of Wood

Stained Wood

Pair your favorite hint of color with the natural beauty of wood and turn your new cabinetry into fine furniture for your kitchen. Our 14-step finishing process adds depth and richness to wood's color while bringing out the beauty of the grain.

Specialty Finishes

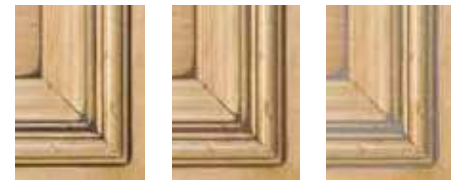

BROWN GLAZE MOCHA GLAZE NICKEL GLAZE

Glaze

Wood is stained, then if desired, distressed. Glaze is hand-applied and rubbed away leaving color collected in crevices unique to each door style.



Aged

Painted or stained wood is randomly dented with special tools to cause stress cracks, and sealed with a clear top coat.



Worn

A blend of rasping, stress cracks, worm holes, dents, and smoothly worn edges. Available on stains with Low Sheen.

Walnut*

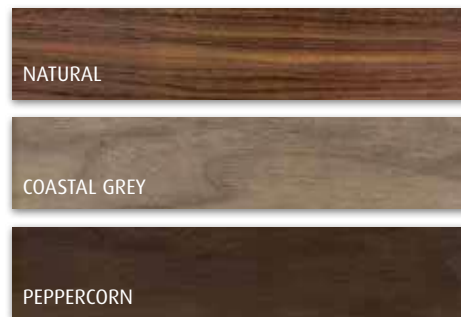

**Walnut is prized for its natural, wide-ranging variations in grain contrast, patterns, and color. Since no single image can capture the variety possible with Walnut, please consult with your designer about what to expect.*

Red Birch

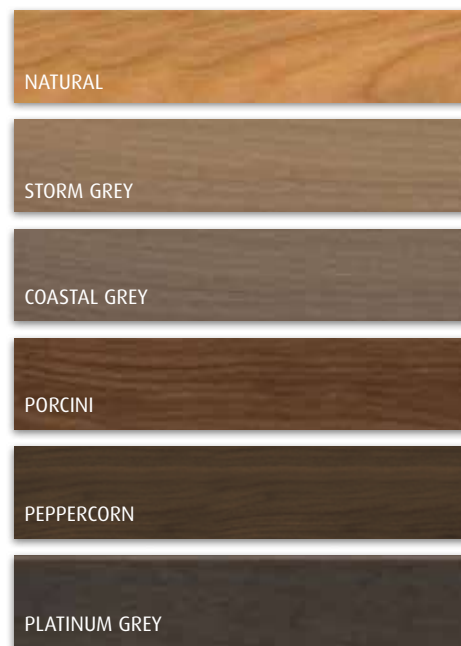

Oak

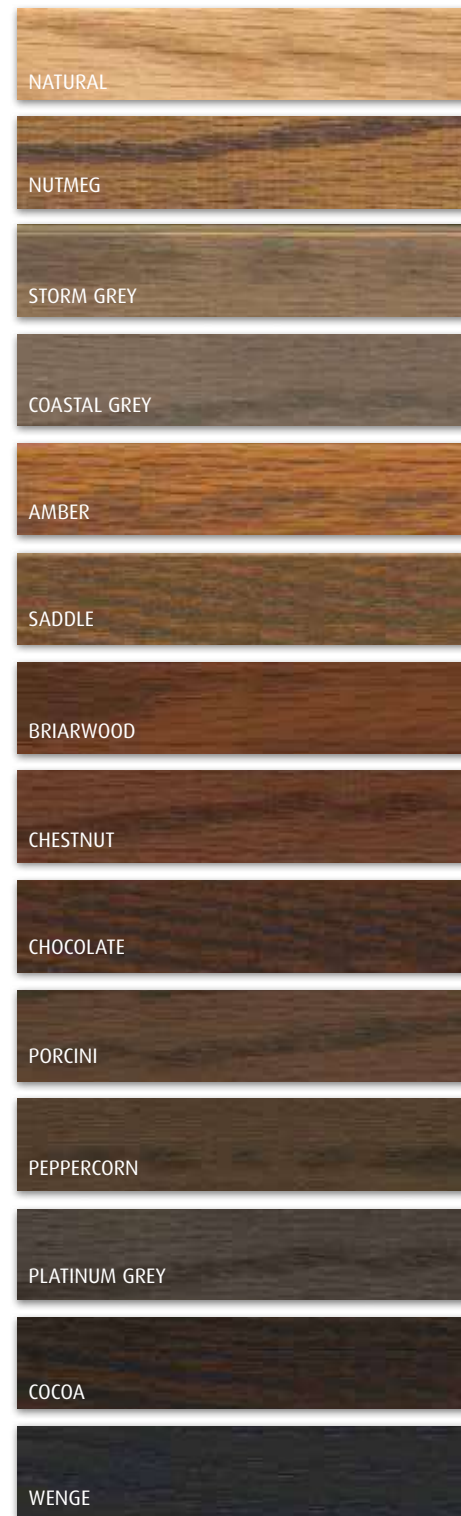

Alder and Rustic Alder

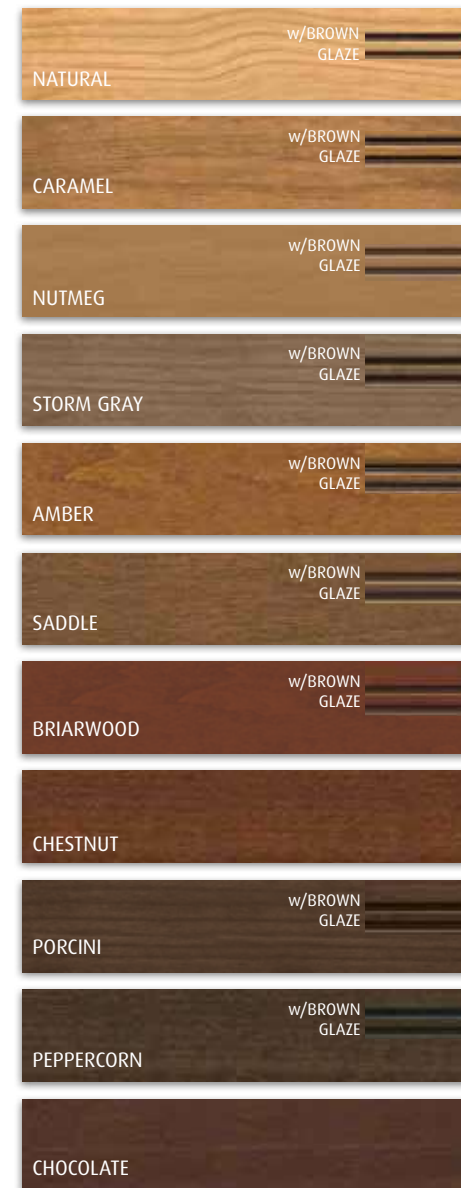

Hand-applied glazing and distressing are custom effects and will be slightly different on each application.

Not all colors and finishes are available on all door styles. Printed and digital materials should never be used for color matching. We recommend ordering a sample door to see the best representation of your selected color, finish, and wood grain contrast and patterns on your selected door style, before ordering cabinetry. Sample doors are more accurate than any website, printed literature, or designer's color chips. See your designer for details.

Cherry and Rustic Cherry

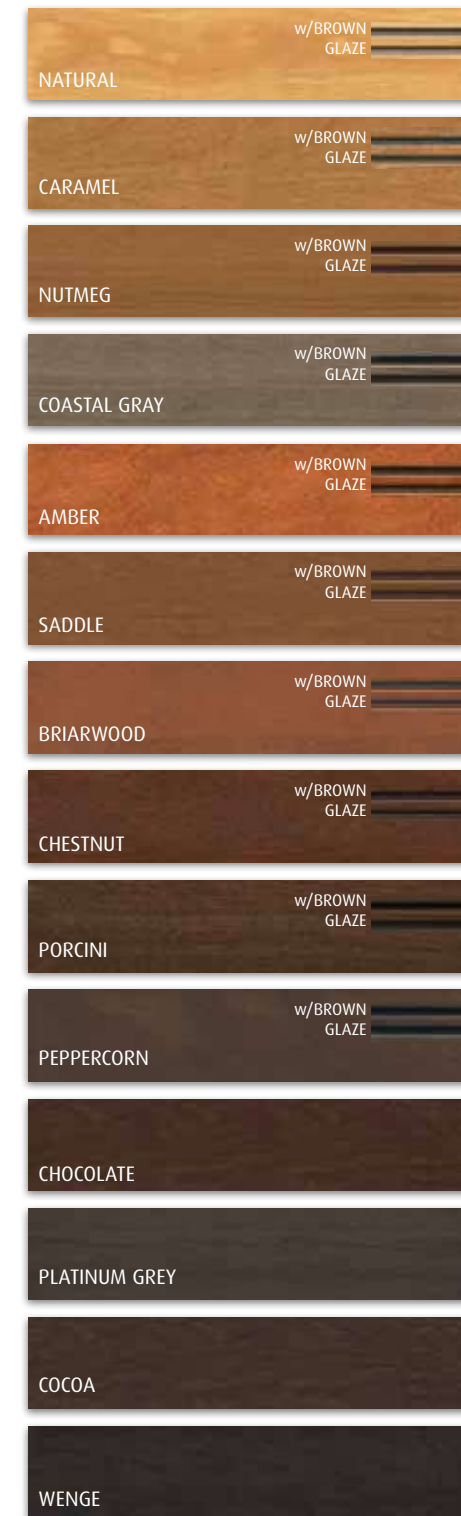

Maple

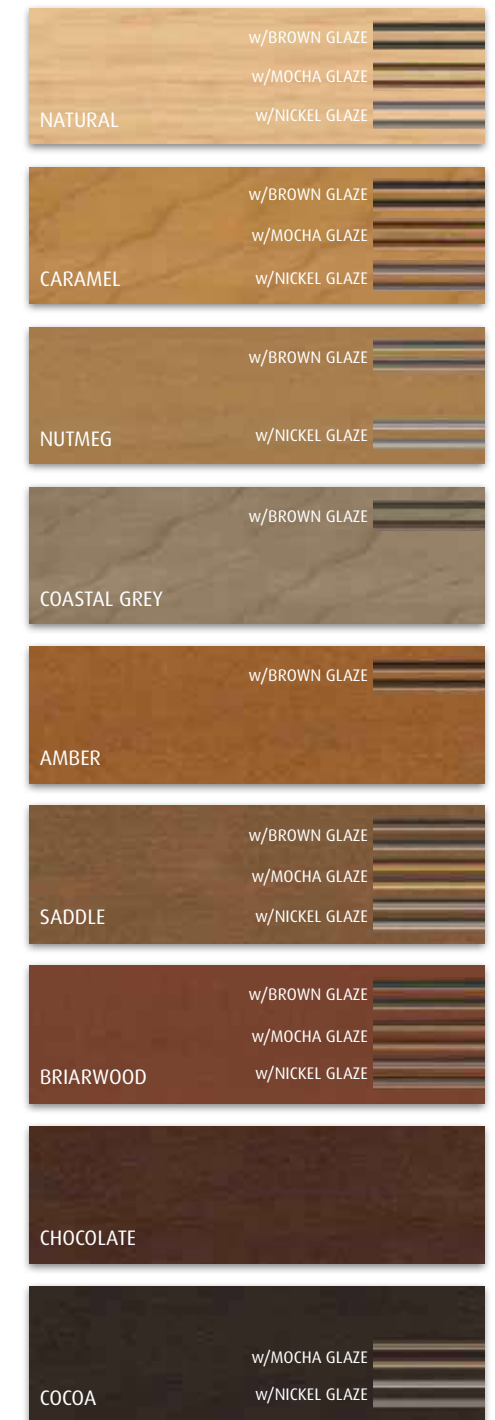

Time-Honored and Current Painted Wood

Painted wood doors are as popular as ever. We use a 14-step, furniture-finishing process for beauty and durability topped off with either Standard or Low Sheen. You can stop there, or you can layer in hand-applied specialty techniques for an even richer, unique look.

Standard Paint Colors

ARCTIC WHITE w/BROWN GLAZE w/MOCHA GLAZE w/NICKEL GLAZE	BEACH WHITE w/BROWN GLAZE w/MOCHA GLAZE w/NICKEL GLAZE	REPOSE GREY w/BROWN GLAZE w/MOCHA GLAZE w/NICKEL GLAZE
SIMPLY WHITE w/BROWN GLAZE w/MOCHA GLAZE w/NICKEL GLAZE	BALBOA MIST w/BROWN GLAZE w/MOCHA GLAZE w/NICKEL GLAZE	LUNAR GRAY w/BROWN GLAZE w/MOCHA GLAZE w/NICKEL GLAZE
MELTED BRIE w/BROWN GLAZE w/MOCHA GLAZE w/NICKEL GLAZE	PEBBLE GREY w/BROWN GLAZE w/MOCHA GLAZE w/NICKEL GLAZE	CREEKSTONE w/BROWN GLAZE w/MOCHA GLAZE w/NICKEL GLAZE
WINGS w/BROWN GLAZE w/MOCHA GLAZE w/NICKEL GLAZE	RAG & BONE w/BROWN GLAZE w/MOCHA GLAZE w/NICKEL GLAZE	STONE w/BROWN GLAZE w/MOCHA GLAZE w/NICKEL GLAZE

Specialty Finishes



BROWN GLAZE MOCHA GLAZE NICKEL GLAZE

Glaze

Wood is painted, then if desired, distressed. Glaze is hand-applied and rubbed away leaving color collected in crevices unique to each door style.



Linen Finishes

Primed and painted wood is lightly hand-brushed with Brown or Nickel glaze creating a linear, brushed look. Available on Maple or MDF with Standard or Low Sheen.



Vintage Finishes

An innovative blend of light glazing, rasping, rub-off, worm holes, stress cracks, dents and smooth worn edges on any paint color on Maple. Sealed with a clear top coat. Low Sheen only.



Rubbed

Primed, painted wood is randomly sanded to reveal bare edges and high points, then sealed with a clear top coat. Add Glaze if available (no Linen, please). Always with Low Sheen.



Aged

Painted or stained wood is randomly dented with special tools to cause stress cracks, and sealed with a clear top coat.



Heritage

A combination of Rubbed and Aged detailing. Available on paints. Always with Low Sheen.

Custom Paint Colors

Don't see what you want in our paint colors? Have your designer send us a paint swatch or a sample of the item you want to match, and our Color Masters will produce a custom paint color just for you. Then we'll produce a full-sized sample door in the style you choose so you can take it home and make sure you love it.



URBAN GRAY w/BROWN GLAZE w/NICKEL GLAZE	MOSS GREEN w/BROWN GLAZE w/MOCHA GLAZE w/NICKEL GLAZE	BLUE ASH w/BROWN GLAZE w/NICKEL GLAZE
NETWORK GREY w/BROWN GLAZE w/NICKEL GLAZE	MINERAL GREY w/BROWN GLAZE w/NICKEL GLAZE	BOTTLE GREEN w/BROWN GLAZE w/MOCHA GLAZE w/NICKEL GLAZE
MOON BAY w/BROWN GLAZE w/MOCHA GLAZE w/NICKEL GLAZE	PEPPER w/BROWN GLAZE w/MOCHA GLAZE w/NICKEL GLAZE	BLACK

Backs of doors are painted, but not glazed or distressed.
Hand-applied glazing and distressing are custom effects and will be slightly different on each application.
Due to the inevitable and natural movement of wood, paint finishes may show some cracking at joints.
This is not considered a defect.

Not all colors and finishes are available on all door styles. Printed and digital materials should never be used for color matching. We recommend ordering a sample door to see the best representation of your selected color, finish, and wood grain contrast and patterns on your selected door style, before ordering cabinetry. Sample doors are more accurate than any website, printed literature, or designer's color chips. See your designer for details.



Crystal Lake door style in Lunar Gray paint with Nickel Linen glaze. Designer: Terry Peacock, Peacock Cabinetry.



Sarasota door style in Stone paint with Brown Linen glaze and in Cherry with Porcini stain and Brown glaze.

Designer: Carina Stephenson, Sr. Design Consultant at Design Studio by Raymond; Architectural & Building Services provided by KTS Group.



Shaker door style in Urban Gray paint. Designer: Angela Goodall, Kitchen Choreography. Photo: Jason Hulet.



Stickley door style in Arctic White paint.



Rockford door style in Repose Grey paint with Brown Linen glaze. Designer: Angela Goodall, Kitchen Choreography. Photo: Jason Hulet.

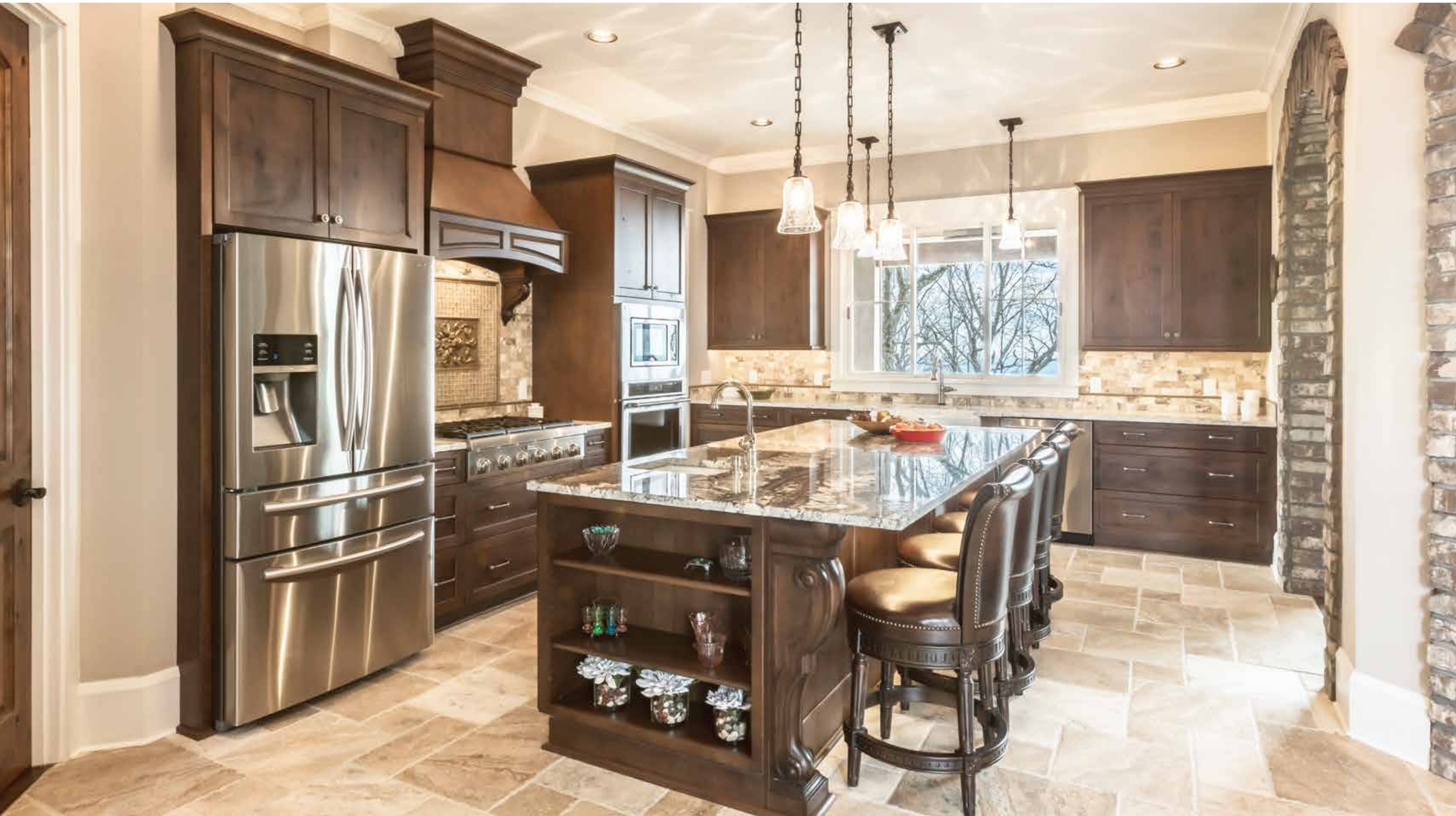

Sagamore door style in Rustic Alder with Saddle stain and Brown glaze. Designer: Rachelle Elliott, NOVA Kitchen and Bath. Photo: Carl Amoth.



Broadview door style in Arctic White and Black, Low Sheen paint.

Designers: Gretchen Ferreira of Style Bath & Kitchen and Meryl Phillips-Miller of Meryl & Miller. Open Homes Photography.

High Style, High Value

Eurotek

The UltraCraft Eurotek Program is a cost-effective solution for achieving the look of wood doors in a quality, low maintenance alternative. You get the benefits of high-style wood aesthetics, in a high-value product.

The woodgrain simulation is created by permanently laminating printed Eurotek veneer to a durable door constructed of medium-density fiberboard (MDF). This

process eliminates expansion and contraction and color variances associated with real wood.

Eurotek not only has a consistent, authentic wood look, but you'll also enjoy the color-fast, durable finish of this smart product. It is beautiful, durable, and affordable. Feel proud and excited about your kitchen, bath, or living spaces, without breaking the bank.



Jamestown door style in Dove White Eurotek. Designer: Kitchen & Bath Design + Construction Design Team. Photo: Chrissy Racho.

Door Styles



CAPE MAY
Matching drawer front
Shown in Grey Opal

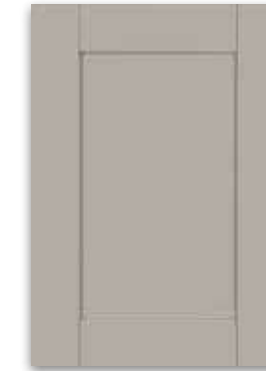

CLERMONT
Matching drawer front
Shown in Grey Mist



JAMESTOWN
Matching drawer front
Shown in Dove White



PHILADELPHIA
Matching drawer front
Shown in Dove White

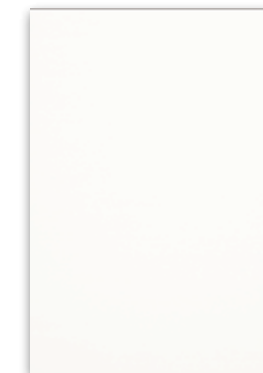

LAKEHURST
Matching drawer front
Shown in Bright White

Finish availability
by door style:
CM = Cape May
C = Clermont
J = Jamestown
P = Philadelphia
L = Lakehurst

Not all colors and finishes are available on all door styles. Printed and digital materials should never be used for color matching. We recommend ordering a sample door to see the best representation of your selected color, finish, and wood grain contrast and patterns on your selected door style, before ordering cabinetry. Sample doors are more accurate than any website, printed literature, or designer's color chips. See your designer for details.

Finishes

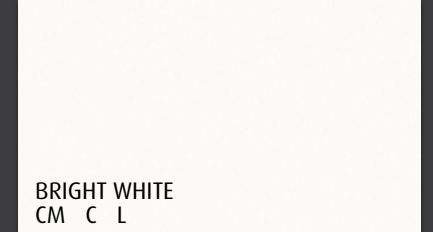

BRIGHT WHITE
CM C L

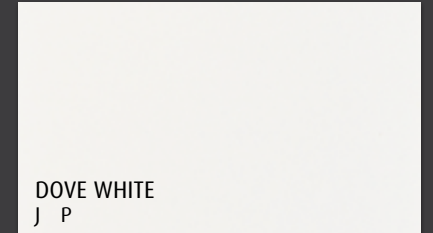

DOVE WHITE
J P

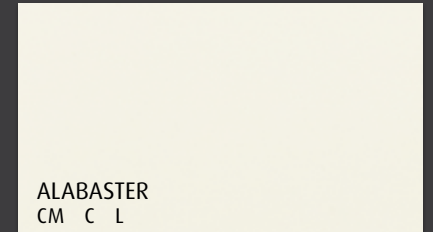

ALABASTER
CM C L



WHITE CYPRESS
CM C

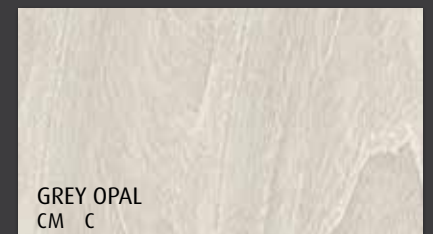

GREY OPAL
CM C

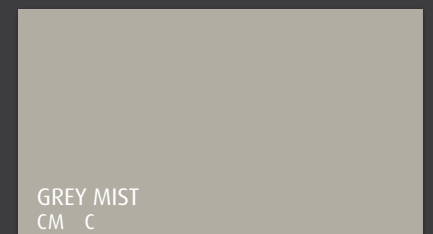

GREY MIST
CM C



Plainview door style in Cherry with Wenge stain (Low Sheen) and Slab door style in Bamboo Vertical with Coastal Grey stain.



AF006 door style in Natural Auminum with Bronze Matte Tech Glass inserts, Piper door style in Charred Vertical, and Archicrete Textured Melamine panels.

A Glint of Jewelry

Metal

Professional and commercial spaces do not hold the sole right to feature metal and glass in a kitchen. Expand your cabinetry design options by considering our versatile metal frames and glass for your central decor theme, or just sprinkled throughout your space.

The light and reflections inherent in glass and metal brighten spaces, granting a clean, polished environment, and can also make your kitchen look more spacious. Going heavier on the amount of metal will result in more of an industrial or commercial flair.

Can't quite go all in with metal and glass? No problem. Create the essence of your space with cabinetry you

love, then add in a little bling. Metal pairs well with all of our other door materials in both transitional and contemporary styles. Just add a couple of metal and glass doors where they make sense functionally or where they can complement your overall design style.

It's easy to pull together beautiful doors from our Metal Program. The metal frames vary in width from barely there to a strong showing and are available in four finishes: Brushed Stainless, Natural Aluminum, Gold, and Onyx. Every combination pairs well with our Tech Glass options. Clear, backpainted, and patterned glass can help you design a you-nique kitchen that isn't found anywhere else in the neighborhood.

Door Styles

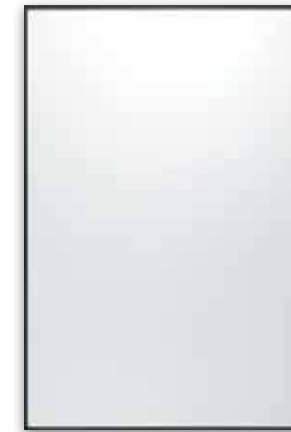

AF006
Shown in Onyx with White Matte Backpainted Tech Glass
Backpainted Glass only; cannot be drilled for hardware



AF002
Shown in Gold with Clear Tech Glass



AF001
Shown in Brushed Stainless with Bronze Matte Backpainted Tech Glass



AF003
Shown Natural Aluminum with Grey Clear Tech Glass

Backpainted Tech Glass should not be lit from behind.

Not all colors and finishes are available on all door styles. Printed and digital materials should never be used for color matching. We recommend ordering a sample door to see the best representation of your selected color, finish, and wood grain contrast and patterns on your selected door style, before ordering cabinetry. Sample doors are more accurate than any website, printed literature, or designer's color chips. See your designer for details.

Tech Glass

Pair Tech Glass with any of our door styles. Available in clear, backpainted and patterned styles, plus a variety of tints, Tech Glass can add moments of contemporary and industrial brilliance to your decor.

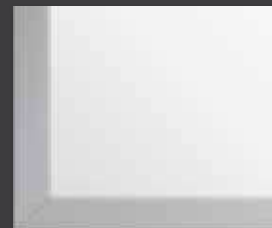

WHITE MATTE BACKPAINTED



SATIN

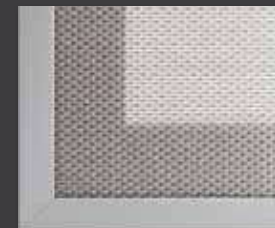

QUATTRO CARBON



MIST MATTE BACKPAINTED



CLEAR



BRONZE CLEAR

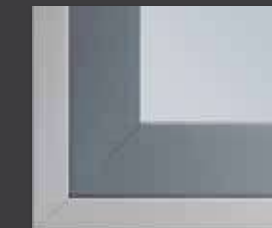

GREY CLEAR



WHITE GLOSS BACKPAINTED



LOW IRON SATIN



LINEA IVORY



MIST GLOSS BACKPAINTED



LOW IRON CLEAR



BRONZE MATTE BACKPAINTED



ONYX



GOLD



BRUSHED STAINLESS



NATURAL ALUMINUM

Show Off A Little!

Art Glass



Mullion Options



Leaded Glass Options



Leaded Glass options are not available with every style of Art Glass. Many patterns are fixed as shown and cannot be altered. Ask your designer for details.



Stickley door style in Rustic Alder with Natural stain and Lakeway door style with Blue Ash paint.



Accessories

The fun of designing a new kitchen kicks up a notch when you're choosing accessories. We offer components that display, hide, spin, pull out, illuminate, and organize.

The cooks in your family will appreciate how well we organize spices, pots and pans, and how we free-up counter space with dedicated storage for idle counter appliances.

When you entertain, LED lighting mellows the mood, Soft Close drawer glides cushion the noise, and built-in wine racks add a sophistication to the evening.

In the ultimate UltraCraft kitchen, everything has a place. The pantries arrange neatly, drawers stay organized, lazy Susans save time, trash bins hide, and the bi-fold, swing-out and flip-up doors are ... well, they're just cool.

Enjoy the process of working with your UltraCraft designer and then revel in your UltraCraft reality!

Accessories

Pull-out, Pull-down, Lift-up, Spin Around

- iMove Pull-down Shelf for Wall Cabinets
- Kessebohmer Pull-out Trays
- Kessebohmer Pull-out Pantry Base Cabinets
- Kessebohmer Lemans Pull-outs in Blind Corner Highboards and Base Cabinets
- Chrome Pull-outs in a Blind Corner Base Cabinet
- Century Pull-out Organizer Base Cabinets
- Century Cookie Tray Pull-out Cabinet
- Century Pull-out Canister Organizer Base Cabinets
- Century Pull-out Knife Block Organizer Base Cabinet
- Narrow Spice Pull-outs
- Glideware Pots & Pans Pull-out
- Kessebohmer Sink Caddy
- Mixer Lift-Up Base Cabinet
- Kessebohmer Larder Tall Cabinets
- Kessebohmer Pantry Tall Cabinets
- Kessebohmer Dispensa Pantry Tall Cabinet
- Century Pantry Pull-out Tall Cabinet
- Century Vanity Hutch Pull-out Organizer



Century Hutch Pull-out Organizer Vanity Cabinets



Kessebohmer Twister Lazy Susans



Wood, Shelf-mounted Lazy Susans



Kessebohmer Chrome Rail Lazy Susans

Lazy Susans

- Kessebohmer Twister
- Wood, Shelf-mounted
- Kessebohmer Chrome Rail



Kessebohmer Pull-outs



Kessebohmer Pantry Pull-out Base Cabinets



Kessebohmer Lemans Pull-outs for Blind Corner Highboard and Base Cabinets



Kessebohmer Larder Tall Cabinets



Kessebohmer Waste Basket Base Cabinets



Hanging Trash Bins Base Cabinets



Revolving Recycle Bins

Clean & Green

- Kessebohmer Waste Basket
- Century Waste Bin
- Hanging Trash Bin
- Single Trash Bin
- Double Trash Bin
- Recycle Bin
- Revolving Recycle Bins
- Vanity Trash Bin



Century Pantry Pull-out Tall Cabinets



Century Organizer Pull-out Base Cabinets



Century Cookie Tray Pull-out Base Cabinets



Century Canister Pull-out Base Cabinets



Glideware Pot-and-Pan Rack



Kessebohmer Sink Caddy



Laundry: Tall Hampers (shown), Base Hampers, Vanity Hampers, Hanging Hampers



Cool Doors: Swing-up, Bi-fold, Flip-up, Metal Tambour Roll-up (shown), and Pocket

Soft-Close Drawer Systems

- Wood Dovetail Drawers w/Soft Close
- Wood Dovetail Pull-outs w/Soft Close
- Metal Drawers w/Soft Close
- Metal Drawers w/Soft Close and Touch-to-Open *Go hardware-free!*
- Metal Pull-outs w/Soft Close



Wood Dovetail Drawers w/Soft Close



Wood Dovetail Pull-outs w/Soft Close



Metal Drawers w/Soft Close



Metal Pull-outs w/Soft Close

Accessories

Drawer Organization

- Pull-out Trays Above Drawers
- 2-Tier Top and Pots & Pans Drawers
- Finition MOVE Boxes
- Finition Pegboard System
- Stainless Steel Dividers
- Dovetail Cutlery Dividers
- K-Cup Holder
- Finition Tray System with Accessories
- Blum Dividers for Top Metal Drawers
- Blum Dividers for Deep Metal Drawers
- Wood Knife Block
- Blum Plastic and Foil Wrap Dispensers
- Convertible Plate Holder
- Bread Bin
- Charging Drawer
- Non-slip Mat



Finition MOVE Boxes



Finition Tray System with Accessories



Finition Pegboard System



Blum Metal Drawer Dividers - Top Drawers



Dovetail Cutlery Insert



Blum Metal Drawer Divider - Deep Drawers



K Cup Drawer Insert



Convertible Plate Holder



Wine Accessories



Wood Stemware Rack



Wine Cubes



Electronics Pull-out Shelf



Open & Floating Wall Shelves



LED Lighting and Glass Shelves



Wainscoting



Decorative Brackets, Corbels, Feet, Legs and Posts



Decorative Valances



Spice Drawers



Letter File



Range Hoods



Appliance Garages



Island Cabinets with Metal Feet

For Wine Lovers

- Chrome Stemware Rack
- Chrome Bottle Rack
- Wood Stemware Rack
- Lattice Wine Cabinet
- Wine Cubes Cabinets

Shelving

- Glass Shelves
- Open/Floating Shelves
- Electronics Pull-out Shelves

Lighting

- PowerPocket LED Puck Lighting
- SimpLED Light Bar System
- LED Flex Tape System

Finishing Touches

- Touch Latches
- Wainscoting
- Walk-Through Pantry Doors
- Mouldings and Trim
- Decorative Brackets, Corbels, Feet, Legs and Posts
- Decorative Valances
- Veneer Wood Tops

Home Work

- Letter Cubbies
- Desk Cabinets
- Hanging Drawers
- File Cabinets
- Trash Bin Cabinets

Leftovers

- Range Hoods
- Appliance Garages
- Wicker Basket Cabinets
- Vegetable Drawer Cabinets
- Tray Divider Cabinets
- Island Cabinets with Feet

UltraCraft Advantages

FULL ACCESS CONSTRUCTION

True Full Overlay: doors cover entire face of the cabinet

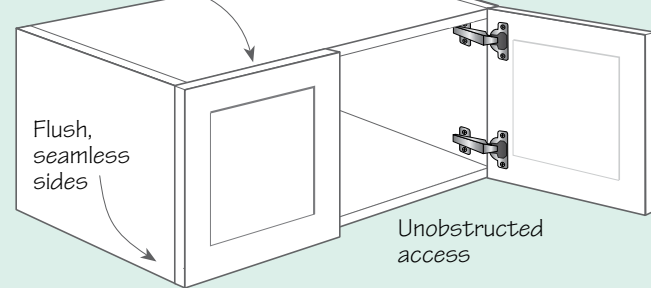

FRAMED CONSTRUCTION

Reveal of the frame shows around the door

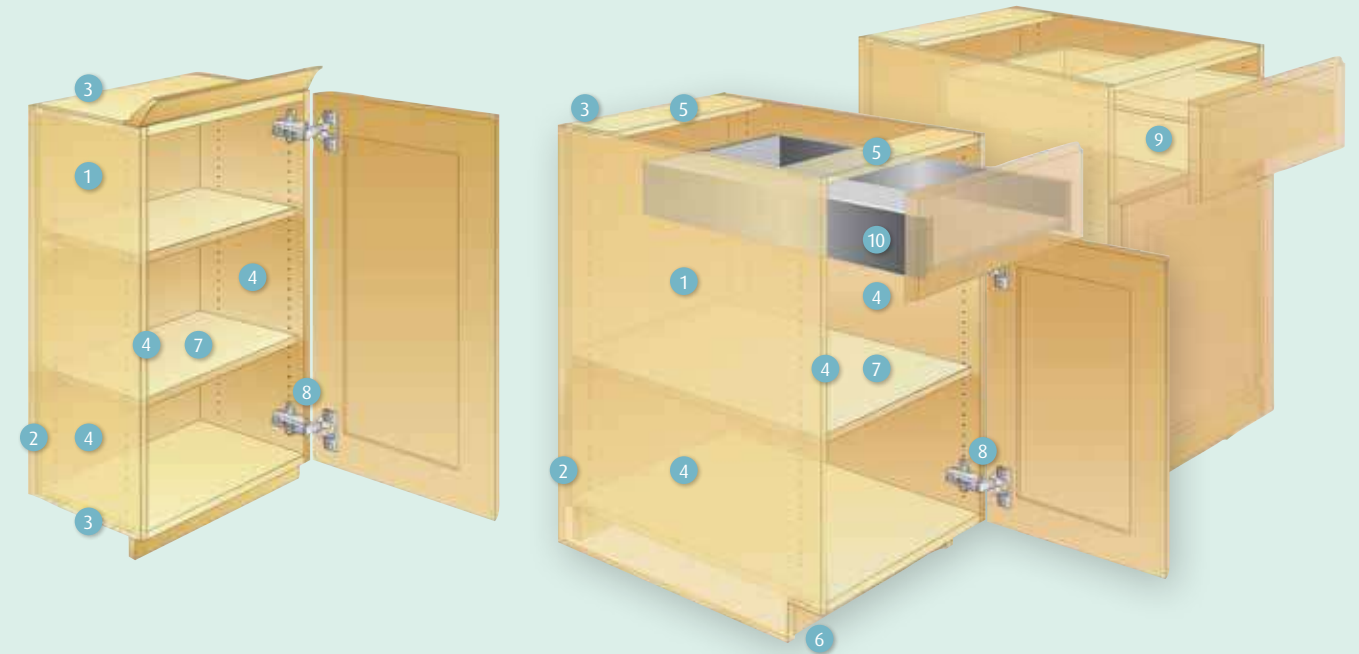
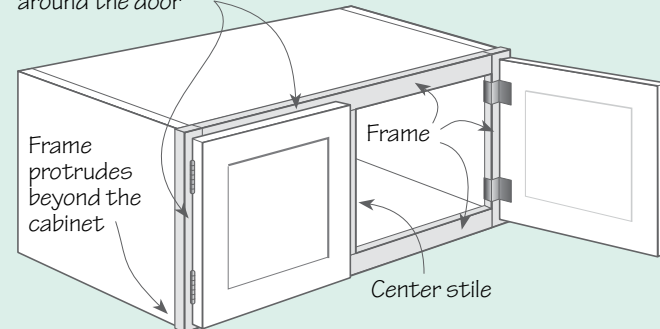

FULL-ACCESS DESIGN

UNOBSTRUCTED ACCESS

A full access, or frameless, cabinet has no knuckle-nicking frame or center stile to impede access to stored items. Cleaning is easier too.

THE CLEANEST LOOK

Instead of a frame sticking out beyond the box, cabinet sides are seamless and flush.

Doors cover the entire face of the cabinet. It's called *true full-overlay*, and it's key to a clean, modern look.

15% MORE STORAGE SPACE!

Best of all, with no frame stealing space from cabinet interiors and drawers, full-access cabinets have up to *15% more storage space!* Go ahead and buy those large plates you've had your eye on.

LEADING-EDGE FASHION, FUNCTION, AND FIT

SO MUCH TO CHOOSE FROM!

We offer a comprehensive selection of today's most-popular styles, finishes and materials from high-gloss to UltraMatte: acrylic, textured melamine, thermofoil, Eurotek, metal, glass, and of course, classic wood. No worries! Your professional UltraCraft kitchen designer will help you choose.

FINE FURNITURE FINISHES

If wood is your style, we offer Oak, Maple, Cherry, Rustic Cherry, Alder, Rustic Alder, Red Birch, and Walnut, and Bamboo and Rift Cut Oak veneers. Select from our palette of stains, paints, custom paints, glazes, Linen and distressed artisan finishes. All hand-crafted with our 14-step finish process.

CUSTOM STORAGE OPTIONS

Outfit your kitchen with accessories for the way you live: pantries, drawer organizers, spice and wine racks, waste and recycle bins... And, your home doesn't stop at the kitchen. Explore storage solutions for the bathroom, home office, playroom, and entertainment centers.

EXPAND YOUR BUDGET

We will custom-modify a cabinet's width, height, and depth, for no charge*. Finished Ends are no charge, as are Finished Interiors.

*up to the next standard size cabinet

CONFIDENCE AND ASSURANCE

TRY BEFORE YOU BUY

Live with your favorites before you decide. With UltraCraft's super-fast Sample Program we can ship samples of your favorite door styles and finishes in about a week.

KINDLY MADE, IN AMERICA

UltraCraft Cabinetry is built in Liberty, NC, in the heart of the country's furniture manufacturing industry, from domestically- and globally-sourced components. We comply with strict CARB II standards.

100-YEAR LIMITED WARRANTY

PERFORMANCE CONSTRUCTION

ARCHITECTURAL SPECIFICATIONS

- Cabinet box** is manufactured with 5/8"-thick, environmentally-friendly, EPP-certified Engineered Furniture Core or All-Plywood panels; dowel-and-glue joinery.
- Back panel** is 5/8"-thick, fully-captured, machine-fitted and provides structural integrity and options for installation screws.
- Top, bottom, and sides** are flush for easier installation, easier application of footed mouldings and light rails, and a furniture-like appearance.
- Finish** for top, bottom and sides – inside and out – is White, Grey or Neutral Woodgrain moisture-resistant melamine. Exposed edges (except inside edges of top stretchers) are edgebanded. Maximum coverage protects against moisture.
- Full-width stretchers**, front and rear, provide solid support and a mounting surface for countertops.
- Toe-space blocking**, front and rear, for stability.
- Shelves** are 3/4"-thick, full-depth, edgebanded, adjustable, and supported with metal shelf clips.
- Hinges** are durable steel, fully-concealed, clip-on/off, self-closing, 110°, 6-way-adjustable (for precision door alignment), with a lifetime manufacturer's warranty and soft-close operation.
- Wood Dovetail Drawers and Pull-outs with Soft Close**
The drawer box has 5/8"-thick, solid wood on all four sides, dovetail joinery at each corner, and 1/4"-thick, fully-captured bottom, all in natural-finish Birch (standard) or Walnut (upgrade). Soft Close glides allow smooth and silent closing. Glides are a full-extension, tandem, undermount system with a 100-lb. static / 90-lb. dynamic-load rating. Glides have a manufacturer's lifetime warranty.
- Metal Drawers and Pull-outs with Soft Close**
Blum Legrabox. Sides are fingerprint-less metal with a stainless steel look. Bottom and back are 5/8"-thick grey melamine. Soft Close glides are a built-in, full-extension, undermount system with 125-lb. static / 110-lb. dynamic-load rating. Glides have a manufacturer's lifetime warranty.

Finished Ends, Finished Interiors, and Panels are color-coordinated with the door finish. Front edges have matching wood or coordinating PVC edgebanding.

Wood Dovetail Drawers are standard on cabinets with all door styles except UltraLux.

10. Metal Drawers and Pull-outs with Soft Close

Blum Legrabox. Sides are fingerprint-less metal with a stainless steel look. Bottom and back are 5/8"-thick grey melamine. Soft Close glides are a built-in, full-extension, undermount system with 125-lb. static / 110-lb. dynamic-load rating. Glides have a manufacturer's lifetime warranty.

Metal Drawers are standard on cabinets with UltraLux door styles and available as an upgrade with all other door styles.

Touch-To-Open

An upgrade to the Metal Drawer. Open the drawer by pressing on the drawer front; eliminate the need for decorative hardware.

ultracraft®

100-Year Limited Warranty

UltraCraft Cabinetry ("We" or "Us") extends the following limited warranty ("Limited Warranty") to the first purchaser ("Original Purchaser" or "You") of a cabinet manufactured by Us (each, a "Product"). This Limited Warranty is only applicable to Products sold and used in the applications described below within the United States and Canada. Except as allowed below, You may not assign or transfer this Limited Warranty.

WHAT DOES THIS LIMITED WARRANTY COVER? Subject to the exclusions and limitations set forth in this Limited Warranty, We warrant to You that each Product will be free from defects in material and workmanship, under normal use and maintenance, for the applicable warranty period stated below. This warranty gives You specific legal rights, and You may have other rights which vary from State to State.

WHAT IS THE WARRANTY PERIOD APPLICABLE TO RESIDENTIAL PURCHASERS? If You are a Residential Purchaser, then the warranty period for Your Product (excluding certain components discussed in the following paragraph) is for as long as You own the dwelling in which Your Product was originally installed and used as a primary or secondary home. Under this Limited Warranty, a "Residential Purchaser" means a person who purchases and installs the Product in a dwelling that is owned and used by that person as a primary or secondary home. A Residential Purchaser also includes any person such as a builder, contractor or developer that purchases and installs the Product in a newly constructed dwelling that will be used as a primary or secondary home. This Limited Warranty may be assigned by a builder, contractor or developer to the first owner of a newly constructed dwelling in which the Product was originally installed, provided that dwelling is used by the first owner as a primary or secondary home. Remodelers, landlords, and leasing companies will be considered a Commercial Purchasers (as defined below).

Notwithstanding the preceding paragraph, the warranty periods applicable to the following Product components that were not originally manufactured by Us are as follows:

- Lighting, Electronic, and Powered components: 2 years from the date of original purchase.
- Decorative Hardware: 5 years from the date of original purchase.
- Cabinet Organizers: 5 years from the date of original purchase.

WHAT IS THE WARRANTY PERIOD APPLICABLE TO COMMERCIAL PURCHASERS? If You are a Commercial Purchaser, then the warranty period for Your Product or any components of Your Product is twelve (12) months from the date of purchase. A "Commercial Purchaser" is any Original Purchaser of a Product that is not a Residential Purchaser. Commercial Purchasers include remodelers, landlords, leasing companies, and other private or public businesses that purchase and install the Product in a dwelling that will be sold, leased or used as a rental unit or for any non-residential purposes.

DISCLAIMER OF OTHER WARRANTIES: THIS LIMITED WARRANTY IS OUR SOLE AND EXCLUSIVE WARRANTY WITH RESPECT TO THE PRODUCTS. ALL IMPLIED WARRANTIES ARE STRICTLY LIMITED TO THE DURATION OF THE LIMITED WARRANTY APPLICABLE TO THE PRODUCT AS STATED ABOVE, INCLUDING BUT NOT LIMITED TO, ANY WARRANTY OF MERCHANTABILITY OR OF FITNESS FOR A PARTICULAR PURPOSE. Some States do not allow limitations on how long an implied warranty lasts, so the above limitation may not apply to You.

WHAT THIS LIMITED WARRANTY DOES NOT COVER (EXCLUSIONS): The Limited Warranty does not apply to any Product:

- (1) installed or used outdoors;
- (2) used for purposes for which it is not designed or intended by Us;
- (3) which have been subjected to misuse, vandalism, abuse, negligence, accident, or unauthorized modifications;
- (4) which have been improperly stored (if the Product must be stored, it should be covered and stored in a humidity and temperature controlled environment, away from direct sunlight);
- (5) which have been improperly installed, cleaned, or maintained (for more information regarding the proper use and care of the Product, please consult the applicable Use and Care Instructions that accompanied the Product or that can be found at www.ultracraft.com/about/100-year-limited-warranty);
- (6) which have been subjected to improper temperature, moisture and/or humidity extremes (temperature outside the range of 50-85°F and humidity outside the range of 30-55% are considered extreme);

- (7) damaged by fire, flood, acts of God, or other external causes beyond our control; and/or
- (8) exhibiting normal wear and tear.

In addition, natural woods may vary in color and characteristics and exhibit subtle changes as they age. For example, painted doors, drawer fronts, and face frames may eventually have visible cracking around the joint area, and cabinet colors may darken or lighten over time. Sunlight, smoke, and other environmental conditions may also affect the color and integrity of the Product's finish or appearance over time. These variations are considered to be the nature of the material in relation to their environmental exposure and are not covered under this Limited Warranty.

Certain household cleaners and other substances may also affect the color and integrity of the Product's finish or appearance over time. Do not use abrasive cleaners, cleaners that contain chlorine, acidic cleaners, scuffing sponges or steel wool because they may scratch and affect the color or finish of the Products. Any such effects on the color and/or integrity of the finish or appearance over time are not considered defects in material or workmanship and are not covered by this Limited Warranty.

ORIGINAL PURCHASER'S SOLE AND EXCLUSIVE REMEDY: In the event of a defect in the workmanship or materials of a Product or Product component, We will, at our option, repair or replace any defective Product or Product component; provided, if it is not commercially feasible to repair or replace a defective Product or Product component, We may refund the original price paid by You for the defective Product or Product component, or provide a credit towards a similar type of product sold by Us. The foregoing are Your sole and exclusive remedies for any Product defect or non-conformity. By way of example but not limitation, the following costs and expenses are not covered by this Limited Warranty: (1) labor costs for the original installation, removal, or reinstallation of the Product, or defective part thereof; (2) labor costs or material charges for the removal, reinstallation, repainting, refinishing or replacement of any other items or building materials which must be removed, replaced, reinstalled, or refinished in order to repair or replace the defective Product or component. For example, costs associated with the following will not be reimbursed: counters, sinks, tiles, flooring, accessories, appliances or plumbing fixtures. When a claim for warpage, joint separation or wood growth is submitted, We may, at our option and after inspection, defer action for up to 12 months to allow the Product to acclimate to the installed environment. Further, We reserve the right to modify or alter any Product design, specifications or materials without obligation to make similar changes to Products previously manufactured or sold by Us.

The repair or replacement remedies offered by Us under this Limited Warranty are contingent on the current Product offerings of styles and construction options within our Product line at the time of a warranty claim is made by You. If a valid warranty claim is filed for an obsolete Product, We reserve the right, at our sole option, to honor its repair or replacement obligations under this Limited Warranty by either: (1) replacing the affected Product or component with a new Product or component of the same or approximate style or color from our current Product line or offerings; or (2) replacing the affected Product or component to achieve a uniform appearance with a similar or comparable product style or approximate color of the originally purchased style. If a Product or components are replaced or repaired, We cannot guarantee an exact match with the finish or appearance of other products or fixtures installed at the Your dwelling. This is due to changes that may occur during the Products' natural aging process, affecting its color and/or grain.

LIMITATION OF LIABILITY: The remedies described above are Your sole and exclusive remedies and our entire liability for any breach of this Limited Warranty. Our total liability shall under no circumstances exceed the actual amount paid by You for the defective product. Further, We shall not under any circumstances be liable for any consequential, indirect, incidental, special or punitive damages or losses, even if this Limited Warranty is deemed to have failed of its essential purpose. Some States do not allow the exclusion or limitation of incidental or consequential damages, so the above limitation or exclusion may not apply to You.

HOW DO YOU OBTAIN WARRANTY SERVICE? This Limited Warranty can also be found online at www.ultracraft.com/about/100-year-limited-warranty [or/and] in the documentation that accompanied your Product. To obtain more information regarding the Product or to make a claim under this Limited Warranty, contact one of our authorized dealers or distributors, who will arrange for inspection of the Product. A dated sales receipt as proof of purchase is required to obtain benefits from this Limited Warranty. If you have difficulty obtaining assistance, please write to:

UltraCraft Cabinetry, Customer Service Department, 6163 Old 421 Road, Liberty NC 27298
Effective date 10/12/17.



CABINET CARE

Your cabinetry is designed to withstand normal, daily household activities and should be treated like fine furniture. Follow these simple recommendations to care for your cabinetry:

WOOD AND EUROTEK CABINERY

The tough, catalyzed varnish protecting your cabinetry should resist foods, beverages, and household agents normally found in today's homes.

WOOD, MELAMINE, METAL, THERMOFOIL, AND EUROTEK CABINERY

Clean cabinet exteriors and interiors using a soft, damp cloth (not a paper towel) and a mild, non-detergent soap (we recommend 100 parts water and 1 part liquid dish soap). Dry immediately. Do not use abrasive soap pads, abrasive cleansers, steel wool, bottled spray cleaners, solvent-based cleaners, or cleaners containing bleach. Wax or polish is not necessary and is not recommended. Excessive moisture can damage the finish. Do not spray cleaner directly on cabinet or allow moisture to seep into seams or joints. Do not leave damp cloths draped over cabinet doors or drawers.

THERMOFOIL CABINERY

Thermofoils, while very durable, can be damaged by excessive heat. Properly-installed Heat Shields protect cabinets adjacent to ovens, ranges, and dishwashers. As a precaution, open doors and drawers away from an oven during high-temperature, self-cleaning cycles. Also, pull countertop appliances, such as toasters, ovens, grills, or coffee makers, out from under the cabinetry before use. Damage caused by excessive heat is not covered under warranty.

ULTRALUX CABINERY

The high-gloss surfaces of UltraLux are covered with a protective film from the manufacturer. Remove the film after cabinet installation. To clean, use a micro-fiber cloth or other very soft cloth with a non-abrasive soap or detergent. Do not use paper towels, brushes, scourers, or scrapers. Avoid harsh household cleaners and abrasives such as acetone, chloroform, benzene, ammonia,

thinners, caustic soda, toluene, xylene, dichloromethane, amyl acetate, glacial acetic acid, butyl alcohol, butyl acetate, Cellosolve, cresols/phenols, ethyl acetate, chlorinated solvents, halogenated solvents, methyl alcohol, methyl ethyl ketone, and sink and toilet bowl cleaners. Safely remove any adhesive near the edges with mineral spirits.

REPAIR KIT

Small nicks and scratches that occur during daily use can be repaired using the products in the Touch-up Kit. Follow all instructions and keep all products out of reach of children.

MARKER: Capillary markers are ready to use, just remove the cap. Valve Markers require shaking to mix the contents. Depress the valve to start the flow, careful not to over-flood the felt tip.

FILL STICK: Fill damages with the stick and gently remove excess material by rubbing with a clean, dry, lint-free cloth.



UltraCraft Advantages

- Hundreds of doors in every popular material, finish, and style from traditional to ultra-modern
- Soft Close Drawers and Doors
- First-class Wood Dovetail and Metal Drawer systems
- Free, custom, size modifications for most cabinets; ask your designer for details
- Designer colors and modern Low Sheen finish at no upcharge
- Custom paint colors
- Popular paint, glaze, linen, and distressed finishes at low upcharges
- All-Plywood or Engineered Furniture Core construction
- Full-Access construction means more storage, easy-to-clean, and precise alignment
- Full-depth, adjustable shelves
- Made in America from domestically- and globally-sourced components
- 100-year Limited Warranty

Front Cover – Piper door style in Vineyard Oak Textured Melamine and South Beach door style in Naval UltraMatte Thermofoil.

Back Cover – Richmond II door style in Oak with Storm Grey stain.

Printed and digital images should not be used for color matching.



©2022 UltraCraft Cabinetry



Printed 11/21/22 PDF Updated 11/21/22

ultracraft®

800.803.2315
www.ultracraft.com